

CIRCUIT SYMBOLS

by

Mysteriousdayz-electronics

demysteryboy.yolasite.com

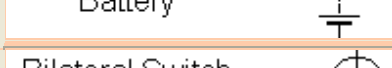
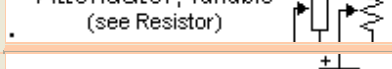
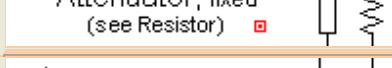
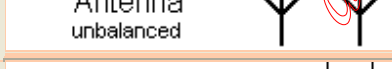
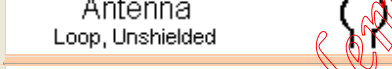
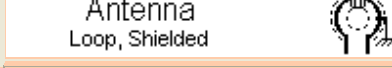
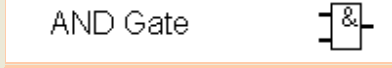
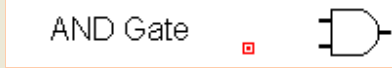
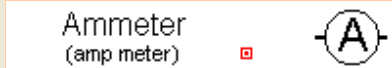
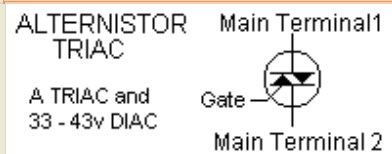

Bridge Rectifier
(Diode Bridge)

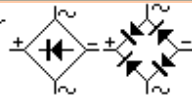

BUFFER
(Amplifier Gate)

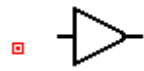

BUFFER
(Amplifier Gate)



Buzzer



Capacitor
feedthrough



Capacitor
non-polarised

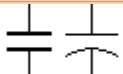

Capacitor polarised
(see electrolytic)

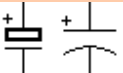

Capacitor
Variable



Cavity Resonator
also
Header (2-pin)

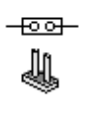

Cell



Circuit Breaker



Ceramic Resonator
Ceramic Filter

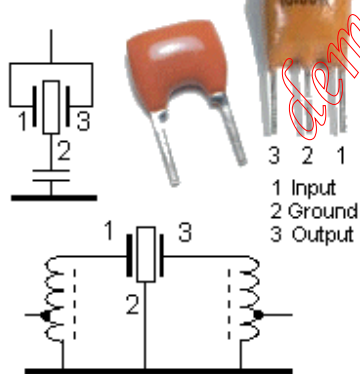



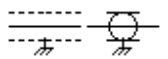



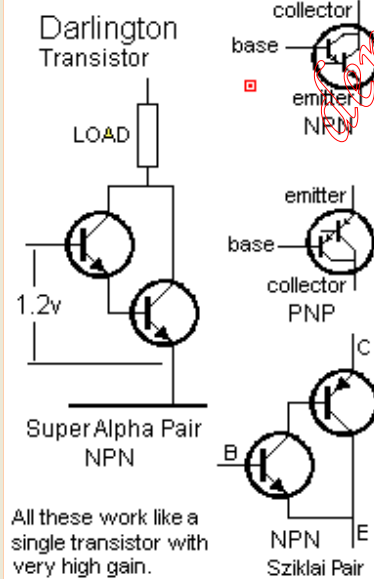
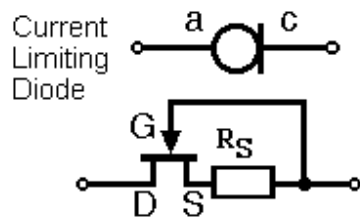
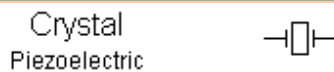
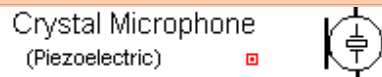
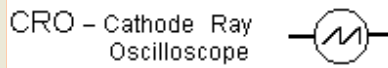
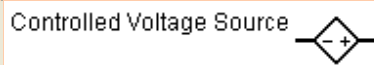
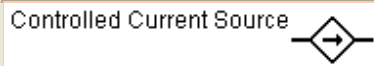
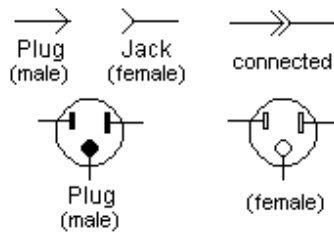

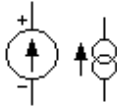





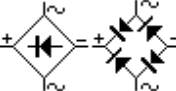

Coaxial Cable

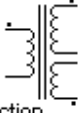
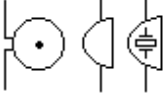

Connectors



| | |
|--|--|
| <p>DC current:  voltage: </p> | |
| <p>Delay Line </p> | |
| <p>DIAC (Bilateral Switch) </p> | |
| <p>Diode  red, black or silver band</p> | |
| <p>Diode - Gunn </p> | |
| <p>Diode - Light Emitting (LED) </p> | |
| <p>Diode Photo Sensitive </p> | |
| <p>Diode Photovoltaic </p> | |
| <p>Diode Bridge (Bridge Rectifier) </p> | |
| <p>Diode - Pin </p> | |
| <p>Diode - Varactor </p> | |
| <p>Diode - Zener </p> | |
| <p>DIP Switch </p> | |
| <p>DOT - dot indicates the start of winding. - dot wires are IN PHASE (if windings are all in same direction)</p>  | |
| <p>Earpiece (earphone, crystal earpiece) </p> | |
| <p>Earth Ground  earth  power ground  signal ground</p> | |

Electroluminescence



Electret Microphone
(Condenser mic)



Electrolytic
(Polarised Capacitor)



alternate symbols:
(positive on top)



Electrolytic - Tantalum

positive end
black or
brown band
or chamfer

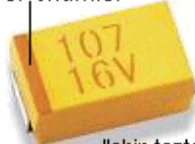

105 = 1u
106 = 10u
107 = 100u

"chip tantalum"

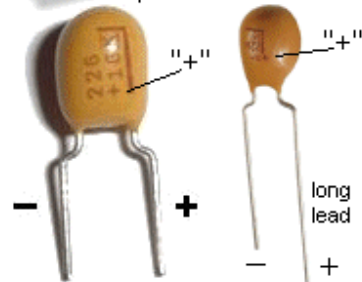

"bead tantalum" or "dipped tantalum"

Exclusive-OR Gate
(XOR Gate)



Exclusive-OR Gate
(XOR Gate)



Ferrite Bead

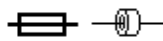

Field Effect
Transistor



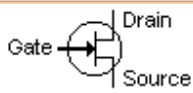





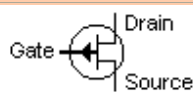

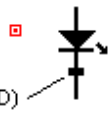
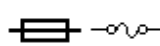
(FET) n-channel
also: N-Channel J FET





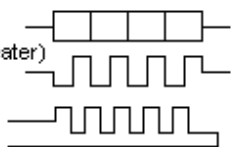
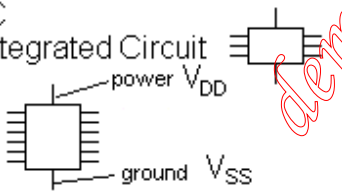



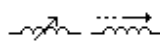

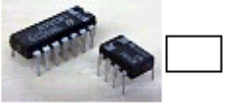



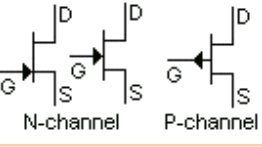

Field Effect
Transistor

(FET) p-channel
also: P-Channel J FET



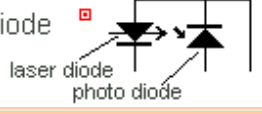

| | |
|--|--|
| <p>Flashing LED (Light Emitting Diode)</p> <p>(Indicates chip inside LED)</p>  | |
| <p>Fuse</p>  | |
| <p>Galvanometer</p>  | |
| <p>Globe</p>  | |
| <p>Ground Chassis</p>  <p>earth power ground signal ground</p> | |
| <p>Ground Earth</p>  <p>earth power ground signal ground</p> | |
| <p>Header (2-pin)</p>  | |
| <p>Headphone</p>  | |
| <p>Heater (immersion heater) (cooker etc)</p>  | |
| <p>IC Integrated Circuit</p>  <p>power V_{DD} ground V_{SS}</p> | |
| <p>Inductor Air Core</p>  | |
| <p>Inductor Iron Core or ferrite core</p>  | |
| <p>Inductor Tapped</p>  | |
| <p>Inductor Variable</p>  | |

| | | |
|--|---|--|
| Integrated Circuit |  | |
| Inverter (NOT Gate) |  | |
| INVERTER (NOT Gate) |  | |
| Jack Co-axial |  | |
| Jack Phone (Phone Jack) |  | |
| Jack Phone (Switched) |  | |
| Jack Phone (3 conductor) |  | |
| JFET (Junction Field Effect) and FET |  | |
| Jumper |  | |
| Key Telegraph (Morse Key) |  | |
| Lamp Incandescent |  | |
| Lamp - Neon |  | |
| LASCR (Light Activated Silicon Controlled Rectifier) |  | |
| LASER diode |  | |
| LDR (Light Dependent Resistor) |  | |
| Light Emitting Diode (LED) |  | |

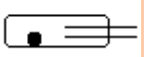
Light Emitting Diode
(LED - flashing) 
(Indicates chip inside LED)

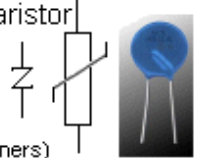
Mercury Switch 

Metal Oxide Varistor
MOV 
(similar to
2 back-to-back zeners)

Micro-amp meter
(micro-ammeter) 

Microphone 
(see Electret Mic)

Microphone
(Crystal - piezoelectric) 

Milliamp meter
(milli-ammeter) 

MOSFET
also IGFET

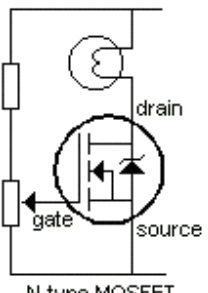

N-type
D
G
S
D
G
S

N-type MOSFET
(BUZ11 IRFZ42)

drain
gate
source

simplified
MOSFET
symbols

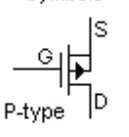

P-type
S
G
D
D
G
S













P-type MOSFET

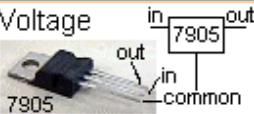





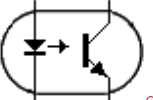
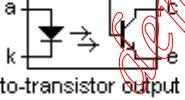
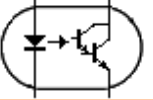
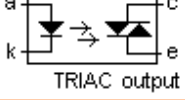







TO220 PACKAGE



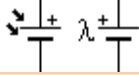

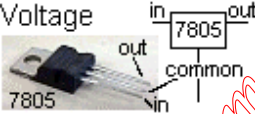

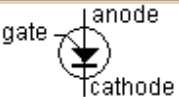
GATE DRAIN SOURCE

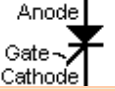
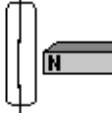





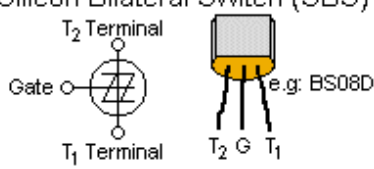
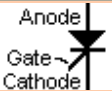
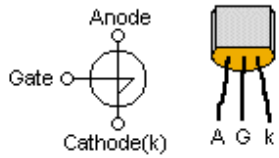
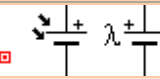

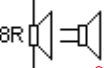
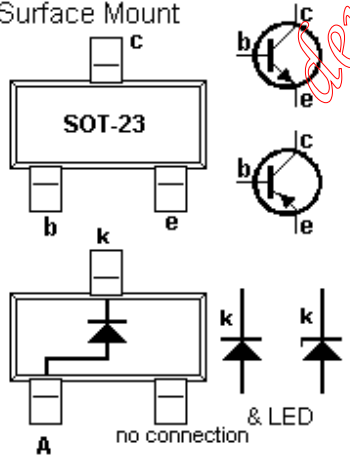
Motor 

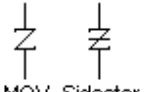
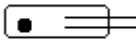
| | | |
|---|---|--|
| NAND Gate |  | |
| NAND Gate |  | |
| Nitinol wire "Muscle wire" |  | |
| Negative Voltage Connection |  | |
| Negative Voltage Regulator (7905 etc) |  | |
| NOR Gate |  | |
| NOR Gate |  | |
| NOT Gate Inverter |  | |
| NOT Gate Inverter |  | |
| Ohm meter |  | |
| Operational Amplifier (Op Amp) |  | |
| Optocoupler (Transistor output) |  | |
| Opto Coupler (Opto-isolator) |  | |
| Optocoupler (Darlington output) |  | |
| Opto Coupler (Opto-isolator) |  | |
| OR Gate |  | |
| OR Gate |  | |

| | | |
|---|---|--|
| Oscilloscope see CRO |  | |
| Outlet (Power Outlet) |  | |
| Piezo Diaphragm |  | |
| Photo Cell (photo sensitive resistor) |  | |
| Photo Darlington Transistor |  | |
| Photo Diode |  | |
| Photo FET (Field Effect Transistor) |  | |
| Photo Transistor |  | |
| Photovoltaic Cell (Solar Cell) |  | |
| Piezo Tweeter (Piezo Speaker) |  | |
| Positive Voltage Connection |  | |
| Positive Voltage Regulator (7805 etc) |  | |
| Potentiometer (variable resistor) |  | |
| Programmable Unijunction Transistor PUT |  | |
| Rectifier Semiconductor |  | |
| Rectifier Silicon Controlled (SCR) |  | |
| Reed Switch |  | |

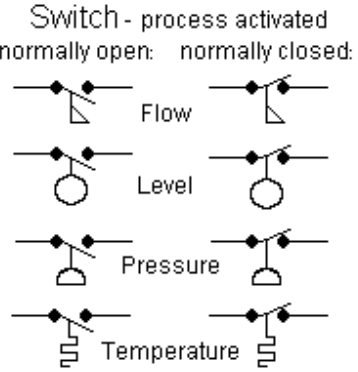
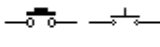
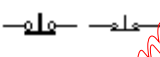
| | | |
|--|--|--|
| Relay - spst | | |
| Relay - spdt | | |
| Relay - dpst | | |
| Relay - dpdt | | |
| Resistor Fixed | | |
| Resistor Non Inductive | | |
| Resistor preset | | |
| Resistor variable | | |
| Resonator 3-pin | | |
| RFC Radio Frequency Choke | | |
| Rheostat (Variable Resistor) (only 2 connections) | | |
| Saturable Reactor | | |
| SAW Filter SAW Resonator (Surface Acoustic Wave) | | |
| Schmitt Trigger (Inverter Gate) | | |
| Schottky Diode (also Shottky) Low forward voltage 0.3v Fast switching also called Schottky Barrier Diode | | |

| | | |
|---|--|--|
| Shielding | ----- | |
| Shockley Diode 4-layer PNPN device Remains off until forward current reaches the forward break-over voltage. |  | |
| Signal Generator |  | |
| Silicon Bilateral Switch (SBS) T ₂ Terminal Gate T ₁ Terminal T ₂ G T ₁ e.g. BS08D |  | |
| Silicon Controlled Rectifier (SCR) Anode Gate Cathode |  | |
| Silicon Unilateral Switch (SUS) Anode Gate Cathode(k) A G k |  | |
| Solar Cell |  | |
| Spark Gap |  | |
| Speaker | 8R  | |
| Surface Mount SOT-23 b c b e k A no connection & LED |  | |

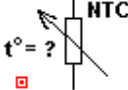
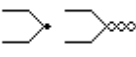
| | | |
|---|---|--|
| Surge Protector (Metal Oxide Varistor) |  MOV Sidactor | |
| Switch - mercury tilt switch |  | |
| Switch - spst |  | |
| Switch - spdt |  | |
| Switch - dpst |  | |
| Switch - dpdt |  | |
| Switch - process activated normally open: normally closed: |  | |
| Switch - push (Push Button) |  | |
| Switch - push off (used in alarms etc) |  | |
| Switch - Rotary |  | |
| Tantalum - see Electrolytic |  | |
| Test Point |  | |
| Thermal Probe NTC: as temp rises, resistance decreases |  | |
| Thermocouple |  | |

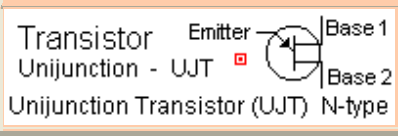
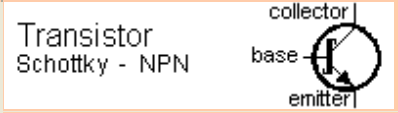
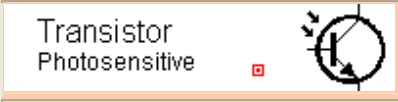
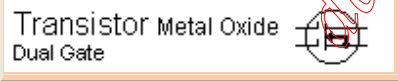
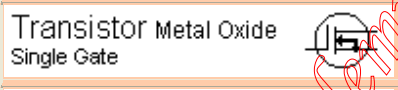
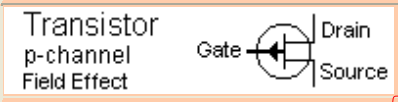
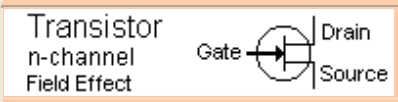
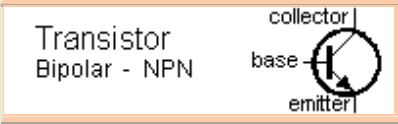
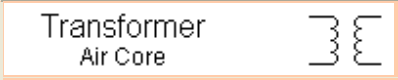
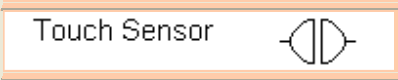
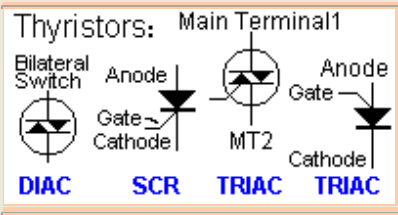

mystreyboy.yolasite.com

Transistor
Unijunction - UJT
Unijunction Transistor (UJT) P-type

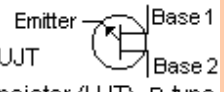

TRIAC

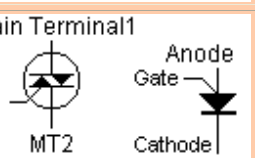

Tunnel Diode

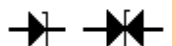

Unijunction Transistor - UJT

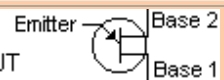

Varistor
(similar to 2 back-to-back zeners)

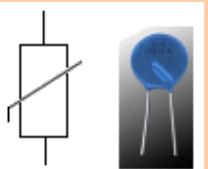

Varactor
varactor diode

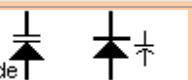

Voltage Dependent Resistor
VDR

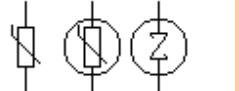

Voltage Regulator
(7805 etc)



Voltmeter



Wattmeter

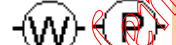

Wires

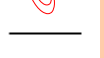

Wires
Connected

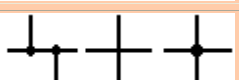

Wires
Not Connected

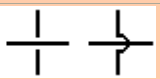

XOR Gate
(exclusive OR)

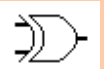

XOR Gate
(exclusive OR)



Zener Diode 

Learn **BASIC ELECTRONICS**
Go to: demystreboy.yolasite.com

email demystreboy@yahoo.com

12-01-2011

demystreboy.yolasite.com